



DOORSLIJPMACHINE

QCUT 250 A

The Qcut 250 A is a compact and flexible semi-automatic abrasive cut-off machine with a 254 mm / 10" cut-off wheel for workpieces or samples up to Ø 95 mm. This machine combines the benefits and speed of a manual cut-off machine with the advantages of an automatic abrasive cutter.

The semi-automatic Qcut 250 A, equipped with a hand lever and automatic lever brake, can be operated with one hand and makes vertical cuts or the positioning of the cut-off wheel easier than before. The cutting table with T-slots is made of stainless steel and can be used either with a dynamic automatic drive (allows pulsed cut) or in manual mode, operated by a hand wheel (traverse cut). Together with the well-proven QATM technology of pulsed cutting, the Qcut 250 A provides excellent cutting results even with the most difficult materials. And having an automatic X-axis allows the Care-Cut (oscillation cut) during a chop cut for large pieces.

For more complex cutting tasks, the Qcut 250 A can be equipped with an optional automatic cross table to perform serial cuts. Axes are monitored by travel measuring during set up and operation.



[Klik om video te bekijken](#)

PRODUCTVOORDELEN

- | Manuele Y-as met elektromechanische positie fixatie
- | Care-Cut: faciliteert gentle cutting

- | 7" Touchscreen gebruiksinterface met intuïtieve QATM gebruikerssoftware
- | Automatische X-as - manuele X-as via handwiel
- | Snijkracht afhankelijk van voedingsregeling (X-as)
- | Superior LED verlichting van de snijkamer
- | Parallele instelling van de wielbeveiliging tijdens opeenvolgende snijprocessen, verhoogt de snijcapaciteit
- | Opening aan beide kanten voor eventuele lange delen

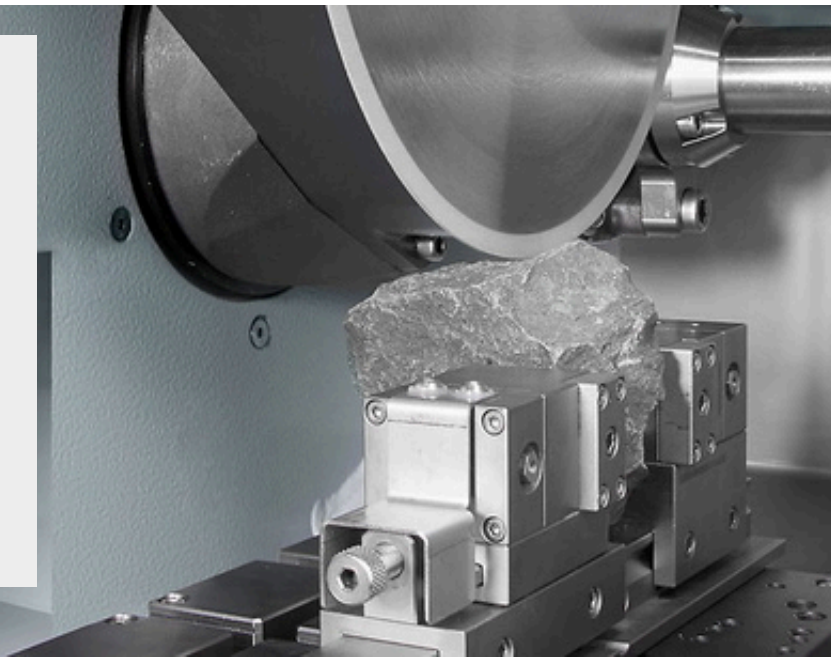

KENMERKEN

FINE DYNAMIC CUT-OFF

With the manual cutting movement, the cutting force is regulated through a set of gears. The cut is thereby jerk-free and more precise. The easy-to-use lever brake fixes the cutting disc in any position.

HORIZONTAL MOVEMENT

The manual horizontal or automatic movement allows cutting long parts longitudinally and easy positioning of the sample below the cut-off wheel. In pulsed cutting mode the sample material is cut particularly gently.

INTUITIVE CONTROL SOFTWARE

The new control software with integrated, extensive maintenance menu makes the operation simple and comfortable.

AUTOMATISCHE DWARSAANVOER

The automatic Z-axis can be adjusted with 0.1 mm precision for parallel cuts.

DOORSLIJPMACHINE QCUT 250 A SUPERIORITY IN DETAIL

1. Large machine table

- | Axes can be positioned backlash-free
- | Easy grooves for simple mounting of QATM clamping devices
- | T-slots 12 mm for individual clamping devices
- | Max. W x H: 380 mm x 270 mm (without Z-axis), otherwise 300 mm x 270

2. Ergonomic control panel

- | 10,1" color touch display
- | Joystick for manual operation

3. Laser alignment

- | For exact component part positioning before cutting

4. Cut-off wheel lock

- | Simplified cutting disc replacement via locking mechanism and easy nut system

5. Side opening

- | For exact component part positioning before cutting

6. Robust housing

- | Sturdy powder-coated aluminum construction

7. Parallel-guided cutting disc cover

- | Increased cutting capacity in cross-cutting

8 Large hand lever

- | Hand lever for precise cross-cuts with automatic locking brake



PERFECT CUTTING - CUT-OFF WHEELS FROM QATM

Cutting is more reliable, safe and efficient when processed with the right ingredients: knowledge, care and the right choice of consumables and instruments.



SNEL, KRACHTIG, FLEXIBEL - KLEMSYSTEMEN VAN QTOOLS

Onze innovatieve klemsystemen worden gebruikt om werkstukken veilig en nauwkeurig vast te klemmen om exact door te slijpen of te polijsten. Er is een uitgebreid pakket aan verschillende klemsystemen beschikbaar, die ontworpen werden voor specifieke toepassingen en werkstuk-afmetingen.

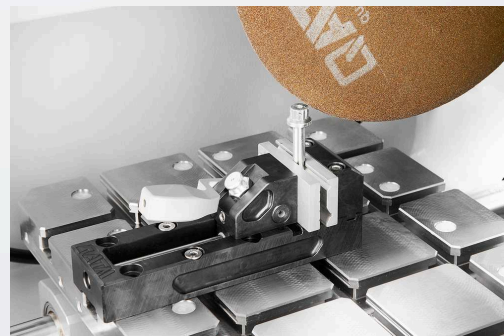

DOORSLIJPMACHINE QCUT 250 A

TECHNISCHE GEGEVENS

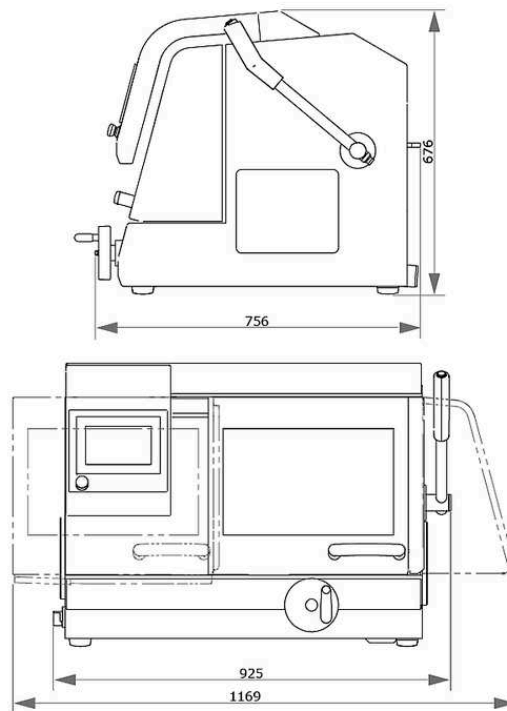

Doorslijpschijf	up to 254 mm / 10"
Max. cutting capacity	ø 95 mm
X-as automatisch & handmatig	225 mm
Y-axis manual	170 mm
Z-axis automatic (option)	120 mm
Precisie Z-as	0.1 mm
Table without Z-axis WxD	380 x 270 mm
Table with Z-axis WxD	300 x 270 mm
T-slot	12 mm
Aansluitvermogen	5.5 kVA
Vermogen aanrijving (hoofdaandrijving)	3 kW, S1; 4 kW, S3/60%
Snelheid	3015 rpm at 50Hz and 3100 rpm at 60Hz
B x H x D	925 x 676 x 756 mm
Weight (depends on equipment)	~ 130 kg

www.qatm.com/qcut-250-a

BESTELGEGEVENS

BASIS UITRUSTING

MACHINE (ALLE POSITIES NOODZAKELIJK)

M1822000  Qcut 250 A (Brillant 240) Base machine

STROOMVOORZIENING (1 ITEM NOODZAKELIJK)

A1822001 Qcut 250 A power connection 400V/50Hz (3Ph/PE)

A1822002 Qcut 250 A power connection 480V/60Hz (3Ph/PE)

A1822003 Qcut 250 A power connection 220V/60Hz (3Ph/PE)

TABLE DRIVE BRILLANT (1 ITEM REQUIRED)

A1822004 Qcut 250 A X-Axis aut.&manual / without Z-Axis

A1822005 Qcut 250 A X-Axis aut.&manual / Z-Axis aut.

RECIRCULATION SYSTEM (1 ITEM REQUIRED)

A5800484  Recirculation Cooling System 45L 400V/50Hz (3Ph/PE) mobile, with insertion mechanism

A5800485  Recirculation Cooling System 45L 480V/60Hz (3Ph/PE) mobile, with insertion mechanism

A5800486  Recirculation Cooling System 45L 220V/60Hz (3Ph/PE) mobile, with insertion mechanism

A5800487  Recirculation Cooling System 45L 400V/50Hz (3Ph/PE) mobile, without folding wheels

A5800488  Recirculation Cooling System 45L 480V/60Hz (3Ph/PE) mobile, without folding wheels

A5800489  Recirculation Cooling System 45L 220V/60Hz (3Ph/PE) mobile, without folding wheels

A6501009  Belt filter 130 - 400V/50Hz (3Ph/PE)

A6501011  Belt filter 130 - 480V/60Hz (3Ph/PE)

A6501010  Belt filter 130 - 220V/60Hz (3Ph/PE)

Z6501004 Connection set belt filter 130

OPTIONS (TO BE ORDERED WITH MACHINE)

A1822006 Qcut 250 A laser alignment aid

A1822007  Qcut 250 A centrifugal separator 400V 50Hz/480V 60Hz

A1822008  Qcut 250 A centrifugal separator 220V 60Hz

PRECISION CLAMPING DEVICES, CLAMPING_DEVICES, PRECISION_CLAMPING_DEVICES

Z1870035 Sample holder L standard Ø 40 mm open, Clamping_devices,
Precision_clamping_devices

Z1870037 Sample holder L standard Ø 40 mm closed, Clamping_devices,
Precision_clamping_devices

Z1870039 Sample holder L Flex Ø 40 mm, Clamping_devices, Precision_clamping_devices

Z1870043 Sample holder L parallel clamping vice open, Clamping_devices,
Precision_clamping_devices

Z1870041 Sample holder L parallel clamping vice closed, Clamping_devices,
Precision_clamping_devices

Z1870045 Drop shape sample holder L Ø 40 mm, Clamping_devices,
Precision_clamping_devices

Z1870047 Universal clamping vice L, Clamping_devices, Precision_clamping_devices

Z1870049 Matrix clamping vice L, Clamping_devices, Precision_clamping_devices

Z1870054 Mini vice L, Clamping_devices, Precision_clamping_devices

Z1870056 Double parallel vice L, Clamping_devices, Precision_clamping_devices

Z1870058 Adaptor with ball joint L, Clamping_devices, Precision_clamping_devices

Z1870064 Reduction ring Ø 25 mm, Clamping_devices, Precision_clamping_devices

Z1870063 Reduction ring Ø 30 mm, Clamping_devices, Precision_clamping_devices

Z1870071	Reduction ring Ø 40 mm, Clamping_devices, Precision_clamping_devices
Z1870067	Reduction ring 1", Clamping_devices, Precision_clamping_devices
Z1870066	Reduction ring 1 1/4", Clamping_devices, Precision_clamping_devices
Z1870065	Reduction ring 1 1/2", Clamping_devices, Precision_clamping_devices
Z1870068	Manual chuck Ø 32 mm, Clamping_devices, Precision_clamping_devices
Z1870069	Manual chuck Ø 44 mm, Clamping_devices, Precision_clamping_devices
Z1870070	Manual chuck Ø 56 mm, Clamping_devices, Precision_clamping_devices

VACUUM CLAMPING VICES, CLAMPING_DEVICES, PRECISION_CLAMPING_DEVICES

Z1870028	Vacuum sample holder, Clamping_devices, Precision_clamping_devices
01870288	Vacuum holder (sacrificial plate), Clamping_devices, Precision_clamping_devices
Z1304600	Vacuum pump 230V/50Hz for vacuum sample holder, Clamping_devices, Precision_clamping_devices
Z1304634	Vacuum pump 110V/60Hz for vacuum sample holder, Clamping_devices, Precision_clamping_devices

QUICK CLAMPING TOOLS, CLAMPING_DEVICES

QTOOL 60, CLAMPING_DEVICES, QTOOL_SERIES

Z2235200	Qtool 60, Clamping_devices, Qtool_series
02235202	Clamping jaw 32 mm - for Qtool 60, Clamping_devices, Qtool_series
Z2235201	Clamping jaws 60 mm - for Qtool 60, Clamping_devices, Qtool_series
02235212	Clamping jaw 32 mm bevelled - for Qtool 60, Clamping_devices, Qtool_series
02235213	Clamping jaw 32 mm cross prism - for Qtool 60, Clamping_devices, Qtool_series
Z2235202	Clamping jaws 60 mm slotted - for Qtool 60, Clamping_devices, Qtool_series
Z2235203	Clamping jaws 60 mm slotted prism - for Qtool 60, Clamping_devices, Qtool_series

QTOOL 80, CLAMPING_DEVICES, QTOOL_SERIES

Z2231203	Qtool 80 - 100mm, Clamping_devices, Qtool_series
02231243	Clamping jaw 40 mm, Clamping_devices, Qtool_series
Z2231215	Clamping jaws 70 mm, Clamping_devices, Qtool_series
02231245	Clamping jaw 40 mm bevelled, Clamping_devices, Qtool_series

02231246	Clamping jaw 40 mm cross prism, Clamping_devices, Qtool_series
Z2231216	Clamping jaws 70 mm slotted, Clamping_devices, Qtool_series
Z2231217	Clamping jaws 70 mm slotted prism, Clamping_devices, Qtool_series

QTOOL 80 VARIO, CLAMPING_DEVICES, QTOOL_SERIES

Z2231200	Qtool 80 Vario - 100 mm, Clamping_devices, Qtool_series
Z2231210	Workpiece stop, Clamping_devices, Qtool_series
02231200	Clamping jaw, 40 mm - for Qtool 80 Vario, Clamping_devices, Qtool_series
Z2231211	Clamping jaws, 70 mm, Clamping_devices, Qtool_series
02231213	Prism jaw, 40 mm, Clamping_devices, Qtool_series
02231229	Bevelled jaw, 40 mm, Clamping_devices, Qtool_series
02231230	Cross prism jaw, 40 mm, Clamping_devices, Qtool_series
Z2231212	Round bar jaws, 70 mm slotted, Clamping_devices, Qtool_series
Z2231213	Prism jaws, 70 mm slotted, Clamping_devices, Qtool_series
Z2231214	Clamping jaws, 70 mm slotted, Clamping_devices, Qtool_series

EASY-CLAMPING PLATES, CLAMPING_DEVICES, EASY_CLAMPING_PLATES

Z2236030	Easy-clamping plate S, Clamping_devices, Easy_clamping_plates
Z2236031	Easy-clamping plate S with rotating unit, Clamping_devices, Easy_clamping_plates
Z2236035	Easy-clamping plate M, Clamping_devices, Easy_clamping_plates

ACCESSORIES FOR EASY-CLAMPING PLATES

Z2236032	Easy adaption horizontal, Clamping_devices, Easy_clamping_plates
Z2236033	Easy adaption vertical, Clamping_devices, Easy_clamping_plates
Z2236034	Easy adaption Qtool 40 - 60, Clamping_devices, Easy_clamping_plates
Z2236038	Multitower rotating plate, Clamping_devices, Easy_clamping_plates
Z2236039	Multitower, Clamping_devices, Easy_clamping_plates
Z2236040	Swivel unit Qtool 40 - 60, Clamping_devices, Easy_clamping_plates
Z2236036	Easy-multifunctional plate, Clamping_devices, Easy_clamping_plates

CLAMPING ACCESSORIES FOR ROTATING, SWIVELING AND SPECIAL APPLICATIONS, CLAMPING_DEVICES, CLAMPING_ACCESSORIES_SPECIALS

Z2236041	Swivel unit Qtool 60 - 80, Clamping_devices, Clamping_accessories_specials
Z1304643	Screw clammer with Easy-clamping plate M, Clamping_devices, Clamping_accessories_specials
Z1304636	Expansion clamping device, Clamping_devices, Clamping_accessories_specials
Z2236009	Vertical clamp single, Clamping_devices, Clamping_accessories_specials
Z2236010	Vertical clamp double, Clamping_devices, Clamping_accessories_specials
Z2234010	Clamping system X-Clamp 3858, Clamping_devices, Clamping_accessories_specials

CROSS VICES, CLAMPING_DEVICES, CLAMPING_ACCESSORIES_SPECIALS

Z1340010	 Cross vice 50 - 100, Clamping_devices, Clamping_accessories_specials
----------	---

ANGLE AND ROTATING VICES, CLAMPING_DEVICES, CLAMPING_ACCESSORIES_SPECIALS





Z1304001	Angle vice 60, Clamping_devices, Clamping_accessories_specials
01304008	Prism jaw angle vice 60, Clamping_devices, Clamping_accessories_specials

ROTATING DEVICES, CLAMPING_DEVICES, ROTATION_DEVICES

Z1870059	Rotation device type RD1, Clamping_devices, Rotation_devices
Z1891001	Rotation device type RD2.1, Clamping_devices, Rotation_devices

UNIVERSAL VICES AND ACCESSORIES, CLAMPING_DEVICES, UNIVERSAL_VICES_AND_ACCESSORIES

01350022	Prism 120°, Clamping_devices, Universal_vices_and_accessories
01350023	Prism slim, Clamping_devices, Universal_vices_and_accessories
01350024	Prism 90°, Clamping_devices, Universal_vices_and_accessories
01350025	Prism 90° high, Clamping_devices, Universal_vices_and_accessories
Z1350008	 Universal vice Piccolo 54, Clamping_devices, Universal_vices_and_accessories

Z1350010		Suitcase set universal vice Piccolo 54, Clamping_devices, Universal_vices_and_accessories
Z1350012		Universal vice Piccolo 100, Clamping_devices, Universal_vices_and_accessories
Z1350002		Universal vice Mono 61, Clamping_devices, Universal_vices_and_accessories
Z1350004		Suitcase set universal vice Mono 61, Clamping_devices, Universal_vices_and_accessories
Z1350011		Universal vice Mono 132, Clamping_devices, Universal_vices_and_accessories
Z1350005		Universal vice Duo, Clamping_devices, Universal_vices_and_accessories
Z1350006		Chain vice set, Clamping_devices, Universal_vices_and_accessories
92005796		Longitudinal v-shoe, Clamping_devices, Universal_vices_and_accessories
92005797		Traverse v-shoe, Clamping_devices, Universal_vices_and_accessories
92005799		Longitudinal bridge, Clamping_devices, Universal_vices_and_accessories
92005800		Traverse bridge, Clamping_devices, Universal_vices_and_accessories
92005798		Standard clamping shoe, Clamping_devices, Universal_vices_and_accessories
Z1350007		Height adapter 60mm Piccolo, Clamping_devices, Universal_vices_and_accessories
Z1350003		Height adapter 74mm Mono, Clamping_devices, Universal_vices_and_accessories
95003172		Clamping arm extension Piccolo 54 and Mono 61, Clamping_devices, Universal_vices_and_accessories
Z1304591		Fixing screw M6 x 25, Clamping_devices, Universal_vices_and_accessories
95003169		Fixing screw Piccolo M8 x 25, Clamping_devices, Universal_vices_and_accessories
95003170		Fixing screw Piccolo M10 x 25, Clamping_devices, Universal_vices_and_accessories
95003168		Fixing screw Mono M10 x 32, Clamping_devices, Universal_vices_and_accessories
91001157		T-slot nut - stainless M6 x 8, Clamping_devices, Universal_vices_and_accessories
91001161		T-slot nut - stainless M8 x 10, Clamping_devices, Universal_vices_and_accessories
91001159		T-slot nut - stainless M8 x 12, Clamping_devices, Universal_vices_and_accessories
91001158		T-slot nut - stainless M10 x 12, Clamping_devices, Universal_vices_and_accessories