



精密切割机

QCUT 200 A

精密切割机 QCUT 200 A

性能指标

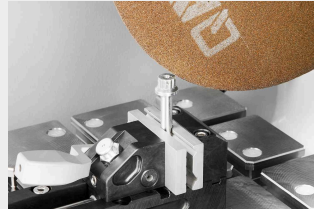

对安全的最高要求

- | 由于采用了使能开关，当切割室门打开时，设备只能通过双手控制定位。
- | 这为机器操作人员消除了挤压风险

智能工件探测

- | 除了经过验证的自动工件探测功能外，本机还具有新型的退出检测（自动停止功能）。
- | 自动检测切割过程的起点和终点，缩短过程时间。

凭借坚固的设计，实现了最高的精度

- | 受益于稳固的结构，机器具有耐用性和低振动特性
- | 以最高的精度对精细样品进行切割或磨削（使用研磨杯轮）
- | 由于有大型滑动门，使用切割室非常方便
- | 可在大切割试台上快速、安全地安装各种类型的夹具

直观极简的操作

- | 大7英寸工业触屏，配有符合人体工程学的用户操作指南
- | 用户友好的软件易于操作
- | 使用操纵杆，可实现自动轴的舒适移动

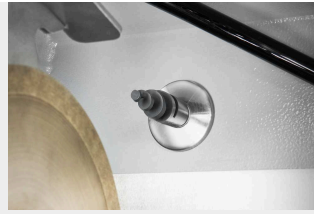

流量监控

- | 通过可选的流量监控，在长时间切割敏感样品时，可以确保持续冷却。
- | 当达到临界阈值时，切割过程自动中断

自动清洗功能

- | 归功于位于切割室内的螺旋喷嘴，可实现全自动清洗
- | 清洗可以单独打开，如果需要，可以在每次切割后自动启动
- | 切割过程中的清晰观察：自动清洗也可以在切割操作期间激活

广泛的切割程序

- | 根据工件的几何形状，可采用横向或纵向切割来减少工件和切割轮之间的接触面积
- | 通过步进切割将工件一层一层地切开，并优化动作角度-特别适合固体物料

此仪器是地质学及矿物学应用的理想选择

精密切割机 QCUT 200 A 不受限制的切割

1. 切割室冲洗

5. 附件

切割室自动清洗

2. 大切割台

- | 轴可以无反弹定位
- | 简洁的凹槽设计，便于QATM夹具的安装
- | 8毫米T型槽用于单独的夹持装置
- | 最大尺寸 长 x 宽: 300 mm x 210 mm

3. 人体工学控制面板

- | 大 7" TFT 触屏显示
- | 用于手动操作的操纵杆

4. 激光辅助定位

- | 用于切割前工件的精确定位
- | 作为标准配置包括在内

通过转动装置或进一步的夹紧装置单独扩展夹持可能性

6. 切割轮锁定

- | 通过锁定功能简化截割轮更换
- | 带集成润滑选项

7. 修刀装置

- | 用于修整金刚石切割轮和研磨杯轮
- | 可以从外部手动操作

8. 烟雾分离器

- | 有效去除切割过程中的冷却剂水雾



QCUT150A和200A适用的最佳配件

循环冷却系统

在切割过程中，最佳的冷却措施至关重要。切割过程中若热量过大，会损伤样品并增加切割轮的磨损。冷却和防腐保护剂能够散热，并同时清除切割室内的碎屑。



15L循环冷却系统

- | 带过滤筒和盖子的便携式系统
- | 占地面积小
- | 易于集成到现有实验室家具中
- | 双室过滤系统



45L循环冷却系统（移动式）

- | 带进水滤网、过滤袋和溢流管的移动式单元
- | 可以放在实验室工作台下面，或者落地柜中
- | 可通过选配泵模块扩展用于切割室冲洗
- | 双室过滤系统，带可拆卸分离滑块



45L循环冷却系统（系统实验室）

- | 带伸缩机构的移动式装置
- | 可以很方便地集成到QATM系统实验室柜和带下架的橱柜中
- | 可通过选配泵模块扩展用于切割室冲洗
- | 带进水滤网、过滤袋和溢流管
- | 双室过滤系统，带可拆卸分离滑块

附件配件

夹具

使用易夹持系统，可以将夹具简单、牢固地固定到工作台上，只需一个螺丝。这样就不必冗长地在工作台T型槽中固定夹具了。易夹持系统是一个创新的补充，对日常工作很有裨益。



易夹持系统底座 S 带旋转功能 + 易适应功能 (垂直)

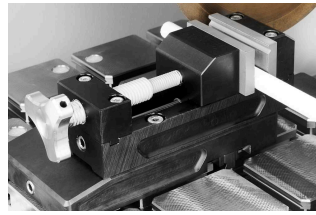

易夹持底座 S 带Qtool 40 S

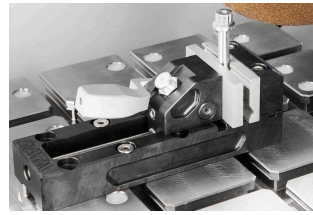

Qtool 40



[点击观看视频](#)

Clamping and cutting of challenging samples (视频)

完美的切割 - 由QPREP耗材保证

当使用正确的元素: 知识、保养和正确选择耗材和切割机进行加工时, 切割更可靠、更安全、更高效。Qprep系列产品包含了专门针对多种材料和不同需求而研发的切割轮。

- | 在切割过程中, 降低对试件的热影响
- | 湿式砂轮切割完成后, 能获得非常精细的表面效果
- | 最佳的切割可缩短后续的制备步骤



精密夹具

QATM的精密系列为常规和不规则形状的样品提供了多种夹持方式, 专为最苛刻和精密的金相应用而设计。

- | 处理不规则和复杂几何形状样品
- | 丰富多样的产品系列
- | 可与旋转装置集成 (Qcut 150 A)
- | 可实现水平和垂直适应



精密切割机 QCUT 200 A

技术参数

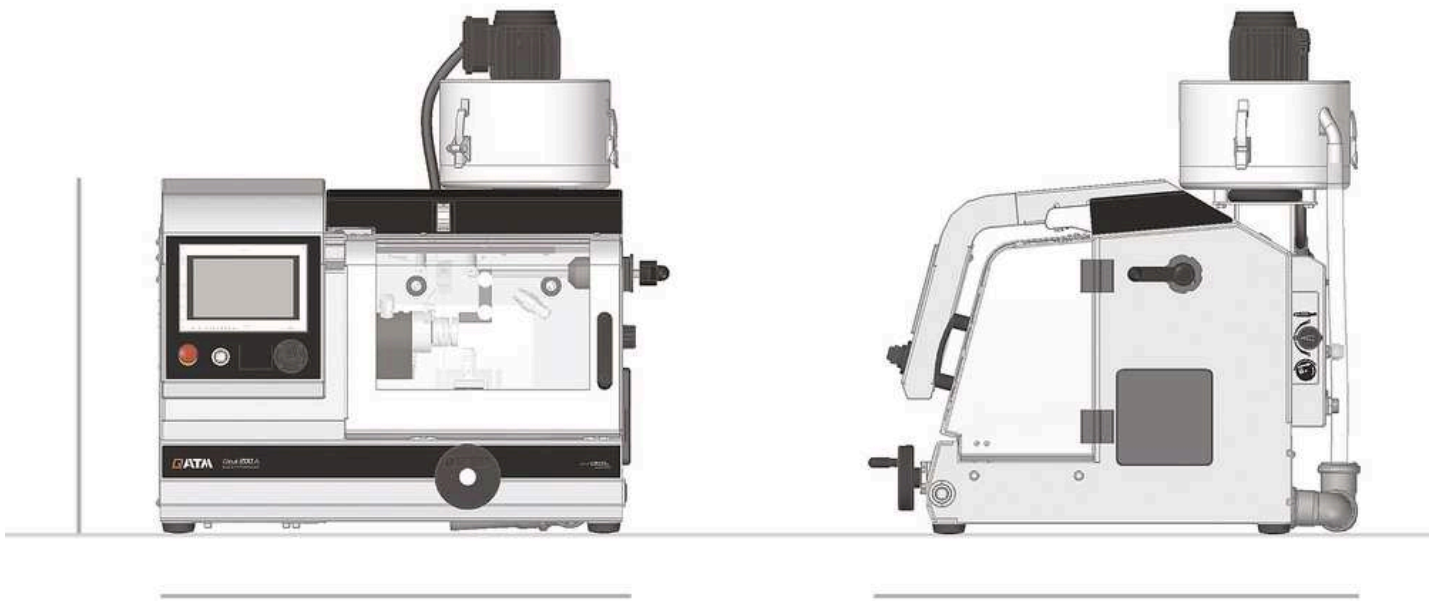

切割轮	up to \varnothing 203 mm / 8"
最大切割能力	75 mm (cut-off wheel \varnothing 200 mm)
切割轮法兰尺寸	\varnothing 12,7 mm
X轴	210 mm (手动/自动)
Y轴	80 mm (自动)
Z轴 (选配)	80 mm (自动)
进给速度	0.01 - 20 mm/s
Z轴精度	0,005 mm
最小交叉进给 (Z轴)	0,001 mm
不含Z轴的工作台 (WxD)	300 x 210 mm
带Z轴的工作台 (WxD)	280 x 210 mm
T型槽	8 mm

转速	300 - 5000 rpm
工作功率 (主载荷)	0,75 kW, S1
连接电源	2,2 kVA
宽 x 高 x 深	725 x 535 x 675 mm
重量	~ 82 kg

www.qatm.cn/qcut-200-a

ORDER DATA

BASIC EQUIPMENT

MACHINE (1 ITEM REQUIRED)

M1891000  Qcut 200 A Base machine 200-240V, 50/60Hz

M1891001  Qcut 200 A Base machine 100-120V, 50/60Hz

CROSS FEED (1 ITEM REQUIRED)

A1891000 Qcut 200 A automatic X, Y axis

A1891001 Qcut 200 A automatic X, Y, Z axis

OPTIONS (TO BE ORDERED WITH MACHINE)

A1891003 Qcut 200 A cutting chamber cleaning

A1891004 Qcut 200 A flow monitoring

A1891005 Qcut 200 A preparation rotation device

Z1891000 Qcut 200 A dressing device

A1891008 Preparation centrifugal separator

Z1891006 Centrifugal separator

A1891002 Preparation fresh water cooling system

RECIRCULATION SYSTEM (1 ITEM REQUIRED)

Z5800011 Qcut 200 A recirculation cooling system 15 Ltr.

Z5800012 Qcut 200 A recirculation cooling system 45 Ltr., mobile

Z5800013 Qcut 200 A recirculation cooling system 45 Ltr., for system lab

Z5800014 Pump module recirculation cooling

Z5800015 Pump module chamber cleaning (not usable with cooling system 15 Ltr.)

OPTIONS (CAN BE ORDERED SEPARATELY)

Z1800002



Sample collector

Z1891001 Rotation device type RD2.1

Z1870050 Flange set Ø 59 mm

Z1870051 Flange set Ø 99 mm

Z1870052 Flange set Ø 139 mm

PRECISION CLAMPING DEVICES, CLAMPING_DEVICES, PRECISION_CLAMPING_DEVICES

Z1870035 Sample holder L standard Ø 40 mm open, Clamping_devices,
Precision_clamping_devices

Z1870037 Sample holder L standard Ø 40 mm closed, Clamping_devices,
Precision_clamping_devices

Z1870039 Sample holder L Flex Ø 40 mm, Clamping_devices, Precision_clamping_devices

Z1870043 Sample holder L parallel clamping vice open, Clamping_devices,
Precision_clamping_devices

Z1870041 Sample holder L parallel clamping vice closed, Clamping_devices,
Precision_clamping_devices

Z1870045 Drop shape sample holder L Ø 40 mm, Clamping_devices,
Precision_clamping_devices

Z1870047 Universal clamping vice L, Clamping_devices, Precision_clamping_devices

Z1870054 Mini vice L, Clamping_devices, Precision_clamping_devices

Z1870056 Double parallel vice L, Clamping_devices, Precision_clamping_devices

Z1870058 Adaptor with ball joint L, Clamping_devices, Precision_clamping_devices

Z1870064 Reduction ring Ø 25 mm, Clamping_devices, Precision_clamping_devices

Z1870063 Reduction ring Ø 30 mm, Clamping_devices, Precision_clamping_devices

Z1870071 Reduction ring Ø 40 mm, Clamping_devices, Precision_clamping_devices

Z1870067 Reduction ring 1", Clamping_devices, Precision_clamping_devices

Z1870066 Reduction ring 1 1/4", Clamping_devices, Precision_clamping_devices

Z1870065 Reduction ring 1 1/2", Clamping_devices, Precision_clamping_devices

Z1870068 Manual chuck Ø 32 mm, Clamping_devices, Precision_clamping_devices

Z1870069 Manual chuck Ø 44 mm, Clamping_devices, Precision_clamping_devices

Z1870070 Manual chuck Ø 56 mm, Clamping_devices, Precision_clamping_devices

VACUUM CLAMPING VICES, CLAMPING_DEVICES, PRECISION_CLAMPING_DEVICES

Z1870028 Vacuum sample holder, Clamping_devices, Precision_clamping_devices

01870288 Vacuum holder (sacrificial plate), Clamping_devices, Precision_clamping_devices

Z1304600 Vacuum pump 230V/50Hz for vacuum sample holder, Clamping_devices, Precision_clamping_devices

Z1304634 Vacuum pump 110V/60Hz for vacuum sample holder, Clamping_devices, Precision_clamping_devices

QUICK CLAMPING TOOLS, CLAMPING_DEVICES

QTOOL 40, CLAMPING_DEVICES, QTOOL_SERIES

Z2270201 Qtool 40 S, Clamping_devices, Qtool_series

Z2270200 Qtool 40, Clamping_devices, Qtool_series

02270202 Clamping jaw 25 mm - for Qtool 40, Clamping_devices, Qtool_series

Z2270202 Clamping jaws 45 mm - for Qtool 40, Clamping_devices, Qtool_series

02270212 Clamping jaw 25 mm bevelled - for Qtool 40, Clamping_devices, Qtool_series

02270213 Clamping jaw 25 mm cross prism - for Qtool 40, Clamping_devices, Qtool_series

Z2270203 Clamping jaws 45 mm slotted - for Qtool 40, Clamping_devices, Qtool_series

Z2270204 Clamping jaws 45 mm slotted prism - for Qtool 40, Clamping_devices, Qtool_series

QTOOL 60, CLAMPING_DEVICES, QTOOL_SERIES

Z2235200 Qtool 60, Clamping_devices, Qtool_series

02235202 Clamping jaw 32 mm - for Qtool 60, Clamping_devices, Qtool_series

Z2235201 Clamping jaws 60 mm - for Qtool 60, Clamping_devices, Qtool_series

02235212 Clamping jaw 32 mm bevelled - for Qtool 60, Clamping_devices, Qtool_series

02235213 Clamping jaw 32 mm cross prism - for Qtool 60, Clamping_devices, Qtool_series

Z2235202 Clamping jaws 60 mm slotted - for Qtool 60, Clamping_devices, Qtool_series

Z2235203 Clamping jaws 60 mm slotted prism - for Qtool 60, Clamping_devices, Qtool_series

EASY-CLAMPING PLATES, CLAMPING_DEVICES,

EASY_CLAMPING_PLATES

Z2236030	Easy-clamping plate S, Clamping_devices, Easy_clamping_plates
Z2236031	Easy-clamping plate S with rotating unit, Clamping_devices, Easy_clamping_plates
Z2236035	Easy-clamping plate M, Clamping_devices, Easy_clamping_plates

ACCESSORIES FOR EASY-CLAMPING PLATES



Z2236032	Easy adaption horizontal, Clamping_devices, Easy_clamping_plates
Z2236033	Easy adaption vertical, Clamping_devices, Easy_clamping_plates
Z2236034	Easy adaption Qtool 40 - 60, Clamping_devices, Easy_clamping_plates
Z2236038	Multitower rotating plate, Clamping_devices, Easy_clamping_plates
Z2236039	Multitower, Clamping_devices, Easy_clamping_plates
Z2236040	Swivel unit Qtool 40 - 60, Clamping_devices, Easy_clamping_plates
Z2236036	Easy-multifunctional plate, Clamping_devices, Easy_clamping_plates

CLAMPING ACCESSORIES FOR ROTATING, SWIVELING AND SPECIAL APPLICATIONS, CLAMPING_DEVICES, CLAMPING_ACCESSORIES_SPECIALS

Z1304643	Screw clamber with Easy-clamping plate M, Clamping_devices, Clamping_accessories_specials
Z1304636	Expansion clamping device, Clamping_devices, Clamping_accessories_specials
Z2236009	Vertical clamp single, Clamping_devices, Clamping_accessories_specials
Z2236010	Vertical clamp double, Clamping_devices, Clamping_accessories_specials
Z2234010	Clamping system X-Clamp 3858, Clamping_devices, Clamping_accessories_specials

UNIVERSAL VICES AND ACCESSORIES, CLAMPING_DEVICES, UNIVERSAL_VICES_AND_ACCESSORIES

01350022	Prism 120°, Clamping_devices, Universal_vices_and_accessories
01350023	Prism slim, Clamping_devices, Universal_vices_and_accessories
01350024	Prism 90°, Clamping_devices, Universal_vices_and_accessories

Z1350008		Universal vice Piccolo 54, Clamping_devices, Universal_vices_and_accessories
Z1350010		Suitcase set universal vice Piccolo 54, Clamping_devices, Universal_vices_and_accessories
Z1350012		Universal vice Piccolo 100, Clamping_devices, Universal_vices_and_accessories
92005796		Longitudinal v-shoe, Clamping_devices, Universal_vices_and_accessories
92005797		Traverse v-shoe, Clamping_devices, Universal_vices_and_accessories
92005799		Longitudinal bridge, Clamping_devices, Universal_vices_and_accessories
92005800		Traverse bridge, Clamping_devices, Universal_vices_and_accessories
92005798		Standard clamping shoe, Clamping_devices, Universal_vices_and_accessories
Z1350007		Height adapter 60mm Piccolo, Clamping_devices, Universal_vices_and_accessories
Z1350003		Height adapter 74mm Mono, Clamping_devices, Universal_vices_and_accessories
95003172		Clamping arm extension Piccolo 54 and Mono 61, Clamping_devices, Universal_vices_and_accessories
Z1304591		Fixing screw M6 x 25, Clamping_devices, Universal_vices_and_accessories
95003169		Fixing screw Piccolo M8 x 25, Clamping_devices, Universal_vices_and_accessories
95003170		Fixing screw Piccolo M10 x 25, Clamping_devices, Universal_vices_and_accessories
95003168		Fixing screw Mono M10 x 32, Clamping_devices, Universal_vices_and_accessories
91001157		T-slot nut - stainless M6 x 8, Clamping_devices, Universal_vices_and_accessories
91001161		T-slot nut - stainless M8 x 10, Clamping_devices, Universal_vices_and_accessories
91001159		T-slot nut - stainless M8 x 12, Clamping_devices, Universal_vices_and_accessories
91001158		T-slot nut - stainless M10 x 12, Clamping_devices, Universal_vices_and_accessories