



精密切断機

## QCUT 200 A



## 精密切断機 QCUT 200 A

### 特長



#### 高い安全性が求められる

- | Due to the enabling switch, the machine can only be positioned via the two-hand control when the door is open.
- | The risk of crushing for the machine operator is virtually eliminated

#### インテリジェントなコンポーネント検出

- | Proven automatic component detection and a new type of exit detection (auto-stop function)
- | Start and end points of the cutting process are automatically detected and process times are shortened

#### HIGHEST PRECISION THANKS TO ROBUST DESIGN

- | Durable and low vibration thanks to stable construction
- | Cutting or grinding (using a cup wheel) of delicate samples with maximum precision
- | Excellent access to the cutting chamber thanks to large sliding door
- | Quick and secure attachment of versatile clamping devices on the large machine table

#### 直感的でシンプルな操作性

- | Large 7" industrial touchscreen with ergonomic user guidance
- | Easy operation of the user-friendly software
- | Comfortable movement of automatic axes using the Joystick

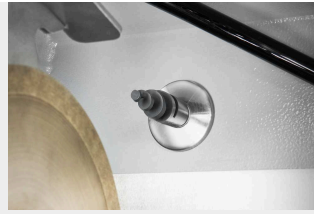

### フローモニタリング

- | Optional flow monitoring ensures constant cooling of sensitive samples even during long cutting processes
- | The cutting process is automatically interrupted as soon as a critical threshold value is reached

### 自動洗浄機能

- | Fully automatic machine cleaning thanks to spiral nozzles in the cutting chamber
- | Cleaning can be switched on individually and starts automatically after each cut if required
- | Clear view during the cutting process: cleaning can be activated during the running process

### 豊富なカッティングプログラム

- | Depending on the geometry of the component, the travel or chop cut is used to minimize the contact area to the cut-off wheel
- | Cut the workpiece layer by layer and optimize the angle of action using the step cut functions – particularly suitable for solid material

地質学や鉱物学のアプリケーションに最適です。

精密切断機 QCUT 200 A

## 制限のない切断

### 1. カuttingチャンバーフラッシング

- | カuttingチャンバーの自動洗浄

### 2. 大型マシンテーブル

- | バックラッシュのない軸の位置決めが可能
- | QATMクランプデバイスを簡単に装着できるイーザーグループ
- | T-slots 8 mm for individual clamping devices
- | 最大:幅×高さ:  
300mm×210mm

### 3. 人間工学に基づいた操作パネル

- | 大型7インチTFTタッチディスプレイ
- | ジョイスティックによる手動操作

### 4. Laser alignment

- | 切断前の部品位置決めを正確に行うことができます。
- | 標準で付属しています

### 5. アクセサリ

- | クランプの可能性は、回転装置やさらなるクランプ装置によって個別に拡張可能です。

### 6. 切断砥石ロック

- | ロック機能により、切断砥石の交換が容易。
- | 潤滑油内蔵オプション

### 7. ドレッシング装置

- | ダイヤモンドの切断砥石や研削砥石の研ぎ出し用
- | 外側から手動で操作することが可能

### 8. Centrifugal separator

- | Effective removal of coolant mist from the sectioning process



OPTIMAL ACCESSORIES FOR QCUT 150 A AND 200 A  
**RECIRCULATION COOLING SYSTEMS**

Optimal cooling is essential during sectioning. Excessive heat generation during the sectioning process damages the specimen and increases the wear of the cut-off wheel. The cooling and corrosion protection agent dissipates the heat and simultaneously removes the chips from the cut-off chamber.



**15L RECIRCULATION COOLING SYSTEM**

- | Portable system with filter cartridge and lid
- | Small footprint required
- | Easy to integrate into existing laboratory furniture
- | Two-chamber system for filtration



**45L RECIRCULATION COOLING SYSTEM (MOBILE)**

- | Mobile unit with inlet strainer, filter bag and overflow
- | Can be placed under a lab bench or floor-to-ceiling cabinet
- | Expandable with optional pump module for cut-off chamber flushing
- | Two-chamber system for filtration with removable separating slide



**45L RECIRCULATION COOLING SYSTEM (SYSTEM LAB)**

- | Mobile unit with retractable mechanism
- | Can be conveniently integrated into QATM system laboratory cabinets and cabinets with undershelves
- | Expandable with optional pump module for cut-off chamber flushing
- | Inlet strainer, filter bag and overflow
- | Two-chamber system for filtration with removable separating slide

アクセサリ  
クランピングツール

Qcut 200 Aには、さまざまなクランプツールが用意されています。イージークランプシステムを使用すれば、ネジ1本でテーブルに簡単かつ確実に固定することができます。これにより、テーブルのT溝にクランプツールを固定する面倒な作業は不要になります。イージークランプシステムは、毎日の仕事に大きな影響を与える革新的な追加機能です。

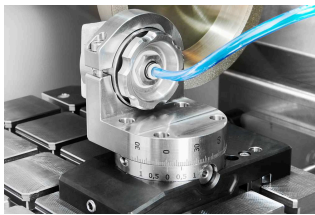

回転機能付きイージークランプベースS+イージーアダプテーション（縦型）

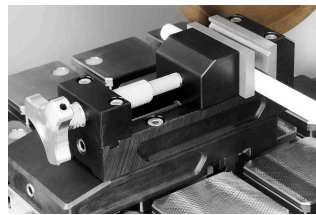

イージークランプベースSとQtool 40 Sの組み合わせ

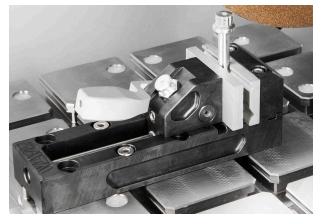

Qtool 40



[クリックして動画を見る](#)

Clamping and cutting of challenging samples (ビデオ)

### パーフェクトカット - QPREPの消耗品

加工要件（知識、慎重な加工、消耗品と機器の正しい選択）を充足することで、信頼性、安全性、効率性の高い切断が実現します。The Qprep range includes specially developed cut-off wheels for a wide variety of materials and requirements.

- | Low thermal influence on the specimen during the cutting process
- | Wet abrasive cutting achieves very fine surface finishes after cutting
- | Optimal cutting shortens the further preparation process



### 精密クランプ装置

The Precision Series from QATM offers versatile clamping for both regular and irregularly shaped samples, designed for the most demanding and precise materialographic applications.

- | Handles Irregular and Complex Geometries
- | Varied and Versatile Product Range
- | Works with Rotating Device Integration (Qcut 150 A)
- | Horizontal and Vertical Adaptation Available



精密切断機 QCUT 200 A

製品仕様

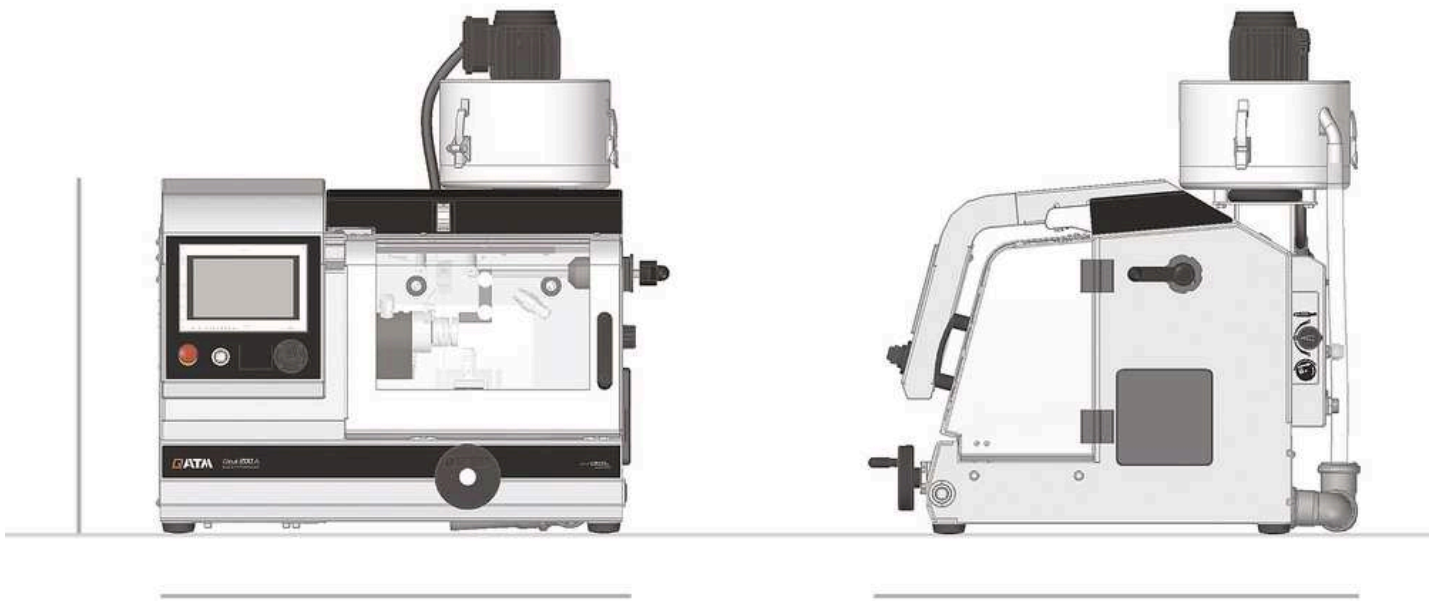

|                   |  |
|-------------------|--|
| 切断ホイール            | up to $\varnothing$ 203 mm / 8"            |
| 最大切断容量            | 75 mm (cut-off wheel $\varnothing$ 200 mm) |
| 切断砥石のフランジ         | $\varnothing$ 12,7 mm                      |
| X-axis            | 210 mm (manual / automatic)                |
| Y-axis            | 80 mm (automatic)                          |
| Z-axis (option)   | 80 mm (automatic)                          |
| 供給率               | 0.01 - 20 mm/s                             |
| Z-軸移動             | 0,005 mm                                   |
| min.クロスフィード(Z軸)   | 0,001 mm                                   |
| Z軸のないテーブル (幅×奥行き) | 300x210mm                                  |
| Z軸付きテーブル (WxD)    | 0.005~3mm/秒                                |
| T-スロット            | 8mm  |

|              |                    |
|--------------|--------------------|
| 回転速度         | 300 - 5000 rpm     |
| 駆動電力 (メイン駆動) | 0,75 kW, S1        |
| 接続ロード        | 2,2 kVA            |
| WxHxD        | 725 x 535 x 675 mm |
| 重量           | ~ 82 kg            |

[www.qatm.com/qcut-200-a](http://www.qatm.com/qcut-200-a)

## 注文データ

### ベース機械

#### 機械 (1アイテム選択)

M1891000  Qcut 200 A Base machine 200-240V, 50/60Hz

M1891001  Qcut 200 A Base machine 100-120V, 50/60Hz

#### クロスフィード (1アイテム選択)

A1891000 Qcut 200 A automatic X, Y axis

A1891001 Qcut 200 A automatic X, Y, Z axis

### オプション (機械と共に選択)

A1891003 Qcut 200 A cutting chamber cleaning

A1891004 Qcut 200 A flow monitoring

A1891005 Qcut 200 A preparation rotation device

Z1891000 Qcut 200 A dressing device

A1891008 Preparation centrifugal separator

Z1891006 Centrifugal separator

A1891002 Preparation fresh water cooling system

#### 循環冷却システム (1アイテム選択)

Z5800011 Qcut 200 A recirculation cooling system 15 Ltr.

Z5800012 Qcut 200 A recirculation cooling system 45 Ltr., mobile

Z5800013 Qcut 200 A recirculation cooling system 45 Ltr., for system lab

Z5800014 Pump module recirculation cooling

Z5800015 Pump module chamber cleaning (not usable with cooling system 15 Ltr.)

### オプション (別発注可)

Z1800002  サンプル回収網

Z1891001 Rotation device type RD2.1

Z1870050 フランジ?セット Ø59mm

Z1870051 フランジ?セット Ø99mm

Z1870052 フランジ?セット Ø139mm

## PRECISION CLAMPING DEVICES, CLAMPING\_DEVICES, PRECISION\_CLAMPING\_DEVICES

Z1870035 サンプル?ホルダー L 標準 Ø40mm オープン, Clamping\_devices,  
Precision\_clamping\_devices

Z1870037 サンプル?ホルダー L 標準 Ø40mm クローズ, Clamping\_devices,  
Precision\_clamping\_devices

Z1870039 サンプル?ホルダー L フレックス Ø40mm, Clamping\_devices,  
Precision\_clamping\_devices

Z1870043 サンプル?ホルダー L 平行クランピング?バイス オープン, Clamping\_devices,  
Precision\_clamping\_devices

Z1870041 サンプル?ホルダー L 平行クランピング?バイス クローズ, Clamping\_devices,  
Precision\_clamping\_devices

Z1870045 水滴型サンプル?ホルダー L Ø40mm, Clamping\_devices, Precision\_clamping\_devices

Z1870047 汎用クランピング?バイス L, Clamping\_devices, Precision\_clamping\_devices

Z1870054 ミニ?バイス L, Clamping\_devices, Precision\_clamping\_devices

Z1870056 ダブル?平行バイス L, Clamping\_devices, Precision\_clamping\_devices

Z1870058 アダプター ボール?ジョイント付 L, Clamping\_devices, Precision\_clamping\_devices

Z1870064 リダクション?リング Ø25mm, Clamping\_devices, Precision\_clamping\_devices

Z1870063 リダクション?リング Ø30mm, Clamping\_devices, Precision\_clamping\_devices

Z1870071 Reduction ring Ø 40 mm, Clamping\_devices, Precision\_clamping\_devices

Z1870067 リダクション?リング 1", Clamping\_devices, Precision\_clamping\_devices

Z1870066 リダクション?リング 1 1/4", Clamping\_devices, Precision\_clamping\_devices

Z1870065 リダクション?リング 1 1/2", Clamping\_devices, Precision\_clamping\_devices

Z1870068 マニュアル?チャック Ø32mm, Clamping\_devices, Precision\_clamping\_devices

Z1870069 マニュアル?チャック Ø44mm, Clamping\_devices, Precision\_clamping\_devices

Z1870070 Manual chuck Ø 56 mm, Clamping\_devices, Precision\_clamping\_devices

#### VACUUM CLAMPING VICES, CLAMPING\_DEVICES, PRECISION\_CLAMPING\_DEVICES

|          |   |
|----------|---|
| Z1870028 | 真空サンプルホルダー, Clamping_devices, Precision_clamping_devices                        |
| 01870288 | Vacuum holder (sacrificial plate), Clamping_devices, Precision_clamping_devices |
| Z1304600 | 真空ポンプ 230V/50Hz 真空サンプルホルダー用, Clamping_devices, Precision_clamping_devices       |
| Z1304634 | 真空ポンプ 110V/60Hz 真空サンプルホルダー用, Clamping_devices, Precision_clamping_devices       |

## QUICK CLAMPING TOOLS, CLAMPING\_DEVICES

#### QTOOL 40, CLAMPING\_DEVICES, QTOOL\_SERIES

|          |  |
|----------|--|
| Z2270201 | Qtool 40 S, Clamping_devices, Qtool_series                                       |
| Z2270200 | Qtool 40, Clamping_devices, Qtool_series   |
| 02270202 | Clamping jaw 25 mm - for Qtool 40, Clamping_devices, Qtool_series                |
| Z2270202 | Clamping jaws 45 mm - for Qtool 40, Clamping_devices, Qtool_series               |
| 02270212 | Clamping jaw 25 mm bevelled - for Qtool 40, Clamping_devices, Qtool_series       |
| 02270213 | Clamping jaw 25 mm cross prism - for Qtool 40, Clamping_devices, Qtool_series    |
| Z2270203 | Clamping jaws 45 mm slotted - for Qtool 40, Clamping_devices, Qtool_series       |
| Z2270204 | Clamping jaws 45 mm slotted prism - for Qtool 40, Clamping_devices, Qtool_series |

#### QTOOL 60, CLAMPING\_DEVICES, QTOOL\_SERIES

|          |  |
|----------|--|
| Z2235200 | Qtool 60, Clamping_devices, Qtool_series   |
| 02235202 | Clamping jaw 32 mm - for Qtool 60, Clamping_devices, Qtool_series                |
| Z2235201 | Clamping jaws 60 mm - for Qtool 60, Clamping_devices, Qtool_series               |
| 02235212 | Clamping jaw 32 mm bevelled - for Qtool 60, Clamping_devices, Qtool_series       |
| 02235213 | Clamping jaw 32 mm cross prism - for Qtool 60, Clamping_devices, Qtool_series    |
| Z2235202 | Clamping jaws 60 mm slotted - for Qtool 60, Clamping_devices, Qtool_series       |
| Z2235203 | Clamping jaws 60 mm slotted prism - for Qtool 60, Clamping_devices, Qtool_series |

## イージークランピングプレート, CLAMPING\_DEVICES,

## EASY\_CLAMPING\_PLATES

|          |  |
|----------|--|
| Z2236030 | Easy-clamping plate S, Clamping_devices, Easy_clamping_plates                    |
| Z2236031 | Easy-clamping plate S with rotating unit, Clamping_devices, Easy_clamping_plates |
| Z2236035 | イージー?クランピング?プレート M, Clamping_devices, Easy_clamping_plates                       |

## ACCESSORIES FOR EASY-CLAMPING PLATES



|          |   |
|----------|---|
| Z2236032 | Easy adaption horizontal, Clamping_devices, Easy_clamping_plates    |
| Z2236033 | Easy adaption vertical, Clamping_devices, Easy_clamping_plates      |
| Z2236034 | Easy adaption Qtool 40 - 60, Clamping_devices, Easy_clamping_plates |
| Z2236038 | Multitower rotating plate, Clamping_devices, Easy_clamping_plates   |
| Z2236039 | Multitower, Clamping_devices, Easy_clamping_plates                  |
| Z2236040 | Swivel unit Qtool 40 - 60, Clamping_devices, Easy_clamping_plates   |
| Z2236036 | Easy-multifunctional plate, Clamping_devices, Easy_clamping_plates  |

## CLAMPING ACCESSORIES FOR ROTATING, SWIVELING AND SPECIAL APPLICATIONS, CLAMPING\_DEVICES, CLAMPING\_ACCESSORIES\_SPECIALS

|          |   |
|----------|---|
| Z1304643 | Screw clamber with Easy-clamping plate M, Clamping_devices, Clamping_accessories_specials |
| Z1304636 | Expansion clamping device, Clamping_devices, Clamping_accessories_specials                |
| Z2236009 | Vertical clamp single, Clamping_devices, Clamping_accessories_specials                    |
| Z2236010 | Vertical clamp double, Clamping_devices, Clamping_accessories_specials                    |
| Z2234010 | Clamping system X-Clamp 3858, Clamping_devices, Clamping_accessories_specials             |

## 汎用バイスとアクセサリ, CLAMPING\_DEVICES, UNIVERSAL\_VICES\_AND\_ACCESSORIES

|          |   |
|----------|---|
| 01350022 | Prism 120°, Clamping_devices, Universal_vices_and_accessories |
| 01350023 | Prism slim, Clamping_devices, Universal_vices_and_accessories |
| 01350024 | Prism 90°, Clamping_devices, Universal_vices_and_accessories  |

|          |   |  |
|----------|---|--|
| Z1350008 |  | ユニバーサル?バイス ピッコロ 54, Clamping_devices, Universal_vices_and_accessories            |
| Z1350010 |  | ユニバーサル?バイス ピッコロ 54 スーツケース?セット, Clamping_devices, Universal_vices_and_accessories |
| Z1350012 |  | ユニバーサル?バイス ピッコロ 100, Clamping_devices, Universal_vices_and_accessories           |
| 92005796 |   | 縦押さえVシュー, Clamping_devices, Universal_vices_and_accessories                      |
| 92005797 |   | 横長Vシュー, Clamping_devices, Universal_vices_and_accessories                        |
| 92005799 |   | 縦長ブリッジ, Clamping_devices, Universal_vices_and_accessories                        |
| 92005800 |   | 横長ブリッジ, Clamping_devices, Universal_vices_and_accessories                        |
| 92005798 |   | 標準クランピング?シュー, Clamping_devices, Universal_vices_and_accessories                  |
| Z1350007 |   | ピッコロ高さアダプター 60mm, Clamping_devices, Universal_vices_and_accessories              |
| Z1350003 |   | モノ高さアダプター 74mm, Clamping_devices, Universal_vices_and_accessories                |
| 95003172 |   | ピッコロ54/モノ61 延長クランピングアーム, Clamping_devices, Universal_vices_and_accessories       |
| Z1304591 |   | フィクシングスクリュー M6x25, Clamping_devices, Universal_vices_and_accessories             |
| 95003169 |   | フィクシングスクリュー ピッコロ M8x25, Clamping_devices, Universal_vices_and_accessories        |
| 95003170 |   | フィクシングスクリュー ピッコロ M10x25, Clamping_devices, Universal_vices_and_accessories       |
| 95003168 |   | フィクシングスクリュー モノ M10x32, Clamping_devices, Universal_vices_and_accessories         |
| 91001157 |   | Tスロットナット ステンレス M6x8, Clamping_devices, Universal_vices_and_accessories           |
| 91001161 |   | Tスロットナット ステンレス M8x10, Clamping_devices, Universal_vices_and_accessories          |
| 91001159 |   | Tスロットナット ステンレス M8x12, Clamping_devices, Universal_vices_and_accessories          |
| 91001158 |   | Tスロットナット ステンレス M10x12, Clamping_devices, Universal_vices_and_accessories         |